

MUNDIAL

INDUSTRIAL PLUGS AND SOCKETS

Description: IP44 SLOPING FLUSH-FIT SOCKET 3P+E 380V 32A 6H

Reference:

03305

Characteristics:

Product type:	Low voltage voltage sloping flush-fit socket
Current:	32A
Poles:	3P+E
Voltage:	380/415 V
Frecuency(Hz):	-
Time code:	6
Colour:	Red
Weight (kg):	1,76
Dimensions:	
Materials:	Halogen-free plastic materials. Plastic parts: polyamide 6. Contacts: copper-zinc alloy
Packaging units:	8

Technical data:

Degree of protection:	IP44
Degree of protection remarks:	
Resistance to impact:	IK08
Glow wire resistance:	960 °C
Ball pressure test:	125 °C
Ambient temperature range:	-25 °C / +40 °C

Certifications and norms:

Directive:	2014/35/EU
Standards:	IEC 60309-1-2
Certificates:	



Codes:

EAN:	8431044033051
Customs tariff number:	85.36.69.90
ETIM 8.0:	EC001317

MUNDIAL

INDUSTRIAL PLUGS AND SOCKETS

Description: IP44 SLOPING FLUSH-FIT SOCKET 3P+E 380V 32A 6H

Reference: 03305

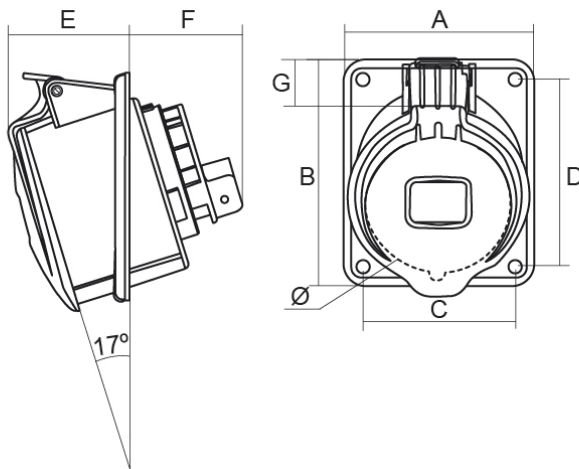

Dimensions:

Current	Poles	Dimensions							
		A	B	C	D	E	F	Ø	G
16 A	2P+E	66	83	50	65	43	43	53	17
	3P+E	66	83	50	65	43	43	60	14
	3P+N+E	80	96	64	79	43	47	66	15
32A	2P+E	80	96	64	79	50	51	68	14
	3P+E	80	96	64	79	50	51	68	14
	3P+N+E	80	96	64	79	50	51	74	11

Sustainability:

RoHS - REACH

Product end of life stage:

Product concerned in the WEEE regulations.

Supply:

Supplied in a single box per packaging multiple